

DLC Display Co., Limited

德爾西顯示器有限公司



MODEL No: DLC0700BKP24RF-2

TEL: 86-755-86029824

FAX: 86-755-86029827

E-MAIL: sales@dlcdisplay.com

WEB: www.dlcdisplay.com



Record of Revision

Date	Revision No.	Summary
2022-03-17	1.0	Rev 1.0 was issued

1. Scope

This data sheet is to introduce the specification of DLC0700BKP24RF-2 active matrix TFT module. It is composed of a color TFT-LCD panel, driver IC, FPC and a backlight unit. The 7.0" display area contains 800(RGB) x 480 pixels.

2. Application

Digital equipments which need color display, mobile navigator/video systems.

3. General Information

Item	Contents	Unit
Size	7.0	inch
Resolution	800(RGB) x 480	/
Interface	RGB	/
Technology type	a-Si TFT	/
Pixel pitch	0.1905 x 0.1905	mm
Pixel Configuration	RGB stripes	
Outline Dimension (W x H x D)	165.00 x 104.60 x 5.30	mm
Active Area	152.40 x 91.44	mm
Display Mode	Transmissive, Normally Black	/
Backlight Type	LED	/
Driver IC	HX5281	/
Viewing Direction	ALL	/
Weight	TBD	g

4. Outline Drawing

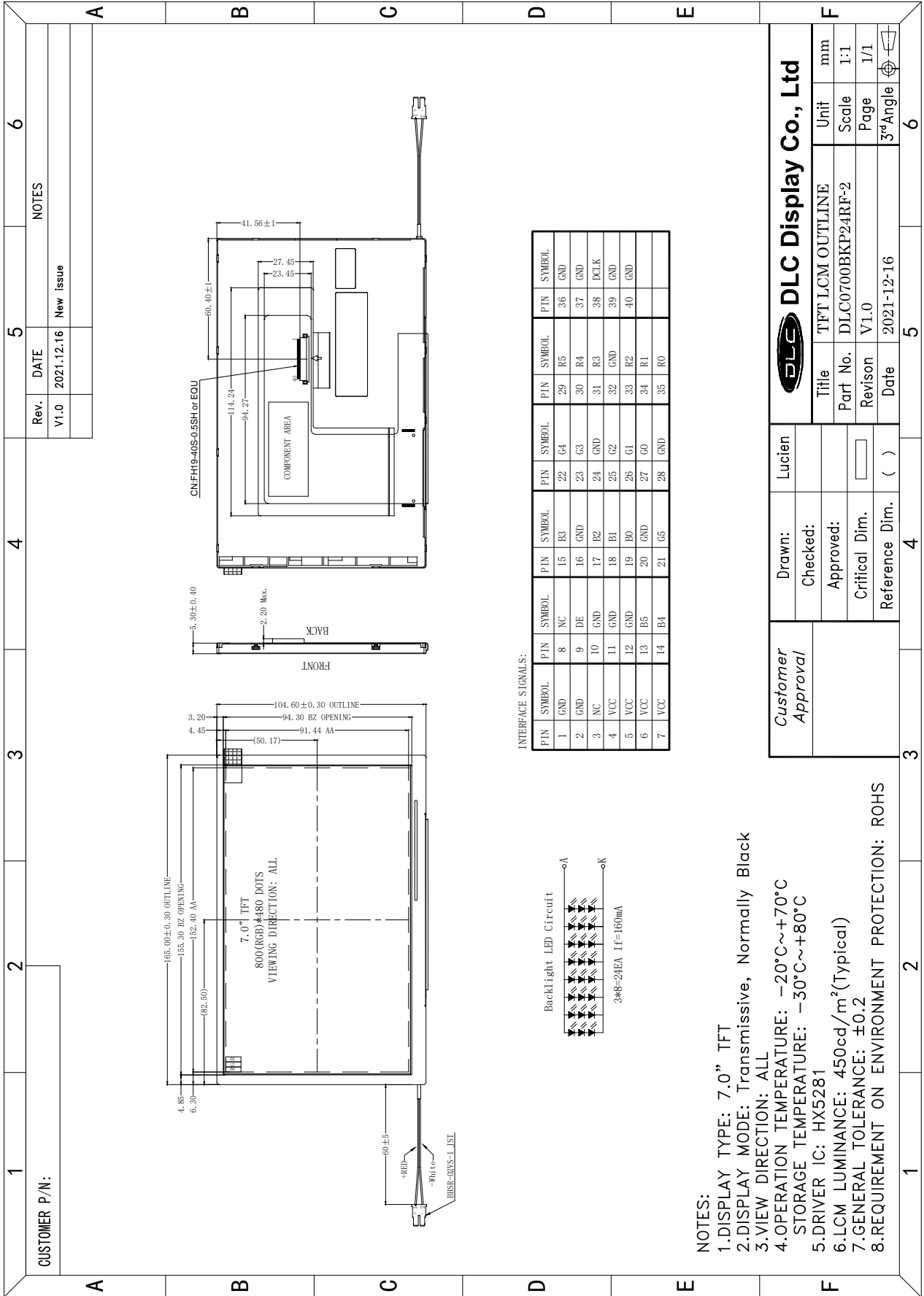

5. Interface signals

Pin No	Symbol	Function
1~2	GND	Ground
3	NC	No connection
4~7	VCC	Power supply
8	NC	No connection
9	DE	Data enable pin
10~12	GND	Ground
13	B5	Blue data bus
14	B4	Blue data bus
15	B3	Blue data bus
16	GND	Ground
17	B2	Blue data bus
18	B1	Blue data bus
19	B0	Blue data bus
20	GND	Ground
21	G5	Green data bus
22	G4	Green data bus
23	G3	Green data bus
24	GND	Ground
25	G2	Green data bus
26	G1	Green data bus
27	G0	Green data bus
28	GND	Ground
29	R5	Red data bus
30	R4	Red data bus
31	R3	Red data bus
32	GND	Ground
33	R2	Red data bus
34	R1	Red data bus
35	R0	Red data bus
36~37	GND	Ground
38	DCLK	Clock signal
39~40	GND	Ground

Note: Recommend connector FH19-40S-0.5SH or Eqv.

Backlight Driving Part

Pin No	Symbol	Function
1	VLED+	LED_Anode, Red
2	VLED-	LED_Cathode, White

Note: The backlight interface connector is a model SM02B-BHSS-1-TB manufactured by JST or equivalent. The matching connector part number is BHSR-20VS-1 manufactured by JST or equivalent.

6. Absolute maximum Ratings

6.1. Electrical Absolute max. ratings

Parameter	Symbol	MIN	MAX	Unit	Remark
Power Supply Voltage	VCC	-0.3	3.6	V	

Notes:

1. If the module is above these absolute maximum ratings. It may become permanently damaged. Using the module within the following electrical characteristic conditions are also exceeded, the module will malfunction and cause poor reliability.
2. VCC >VSS must be maintained.

6.2. Environment Conditions

Item	Symbol	MIN	MAX	Unit	Remark
Operating Temperature	TOPR	-20	70	°C	
Storage Temperature	TSTG	-30	80	°C	

Notes:

1. The response time will become lower when operated at low temperature.
2. Background color changes slightly depending on ambient temperature.
The phenomenon is reversible.
3. Ta≤40°C:85%RH MAX.
Ta>=40°C:Absolute humidity must be lower than the humidity of 85%RH at 40°C.

7. Electrical Specifications

7.1 Electrical characteristics

Ta = 25 °C, GND=0V

Item	Symbol	MIN	TYP	MAX	Unit	Remark
Power supply voltage	VCC	3.0	3.3	3.6	V	
Clock frequency	fCLK	--	30	50	MHz	
Input Signal Voltage	VIL	0	--	0.3*VCC	V	VDD=3.3V
	VIH	0.7*VCC	--	VCC+0.3	V	

Note1: Tested 1x1 chessboard pattern.

7.2 LED Backlight

Ta=25°C

Item	Symbol	MIN	TYP	MAX	Unit	Remark
Forward Current	IF	--	160	--	mA	
Forward Voltage	VF	--	9.0	--	V	
LED life time	-	--	30,000	--	Hrs	Note

Notes:

1.

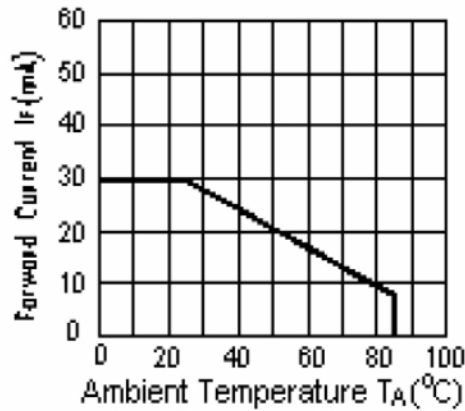

CIRCUIT DIAGRAM

2. The “LED life time” is defined as the module brightness decrease to 50% of original brightness at Ta=25 °C and IF=160mA. The LED life time will be decreased if operating IF is larger than 160mA.

Backlight LED Circuit

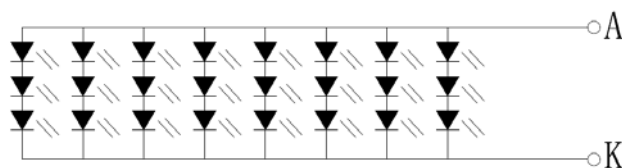

3*8=24EA If=160mA

8. Command/AC Timing

8.1 RGB Timing Characteristics

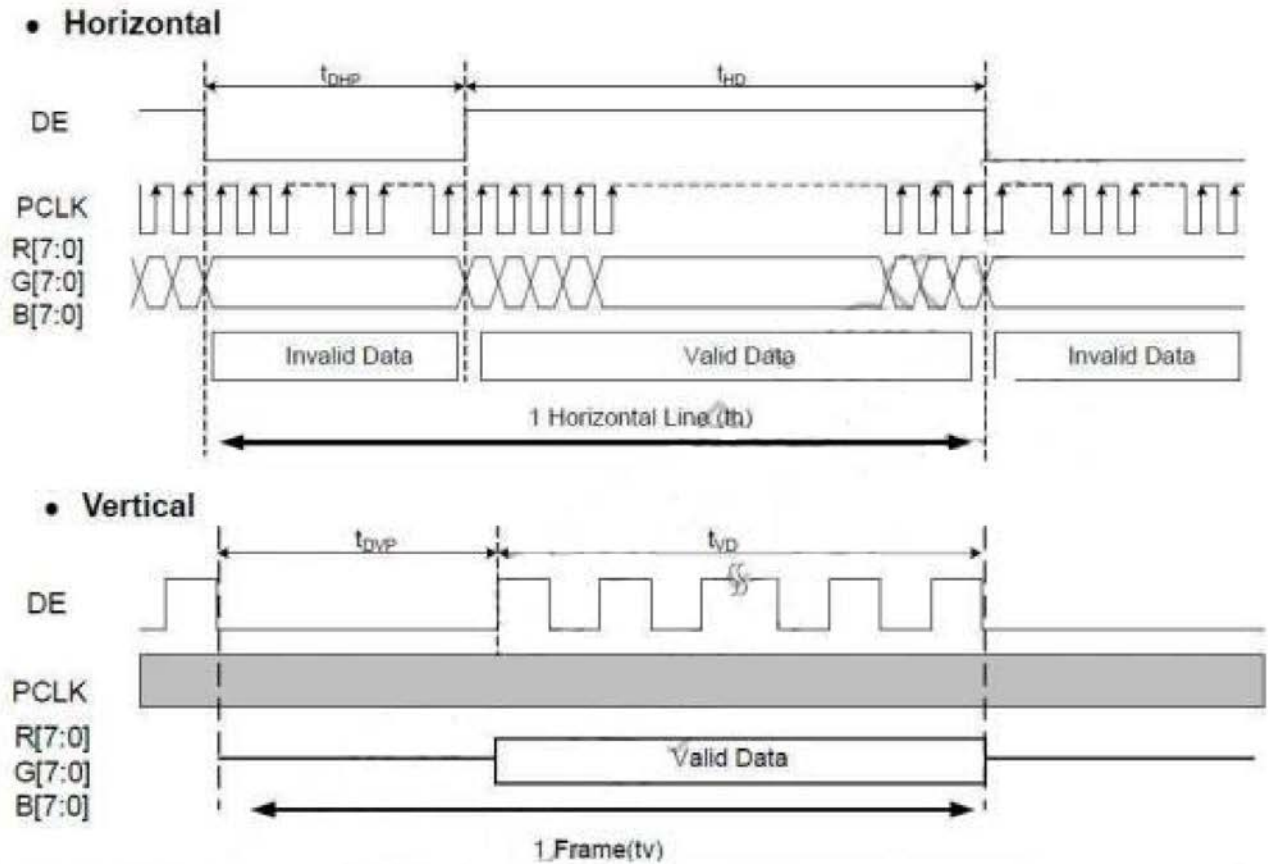

Parameter	Symbol	Min.	Typ.	Max.	Unit
Clock frequency	fdck	25.2	27.2	34.6	MHz
Horizontal valid data	thd	800	800	800	Clocks
1 horizontal line	th	856	860	1100	Clocks
Vertical valid data	tvd	480	480	480	Th
1 vertical field	tv	490	528	528	Th
V frequency	fv	--	60	--	Hz

Input data/sync parameters in RGB interface

(VDDIO=1.65V to 3.6V, VDD1=2.6V to 3.6V, VDD2=2.6V to 3.6V, GND=0V, Ta=-40 to +95°C)

Parameter	Symbol	Min.	Typ.	Max.	Unit
PCLK period	tcom	16.8	8+tr+tf	--	ns
PCLK clock high width	tchw	6	--	--	ns
PCLK clock low width	tclw	6	--	--	ns
VS setup time	tss	3	--	--	ns
VS hold time	tsh	3	--	--	ns
HS setup time	tss	3	--	--	ns
HS hold time	tsh	3	--	--	ns

DE setup time	tss	3	--	--	ns
DE hold time	tsh	3	--	--	ns
Data setup time	tdsu	3	--	--	ns
Data hold time	tdhd	3	--	--	ns
Input signal rising time	tr	--	--	20	ns
Input signal falling time	tf	--	--	20	ns

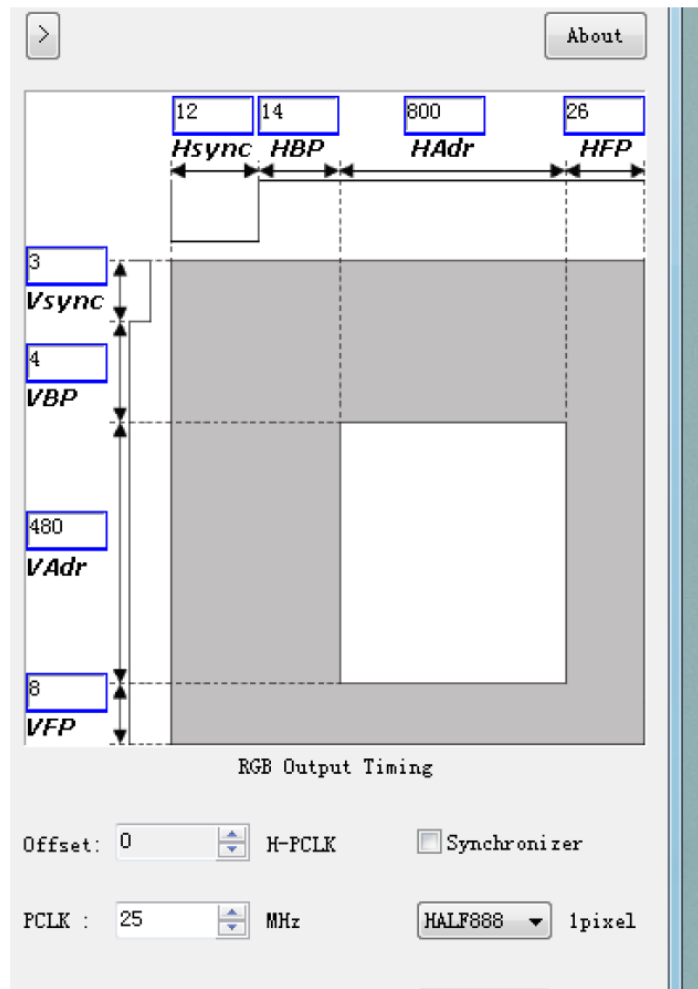
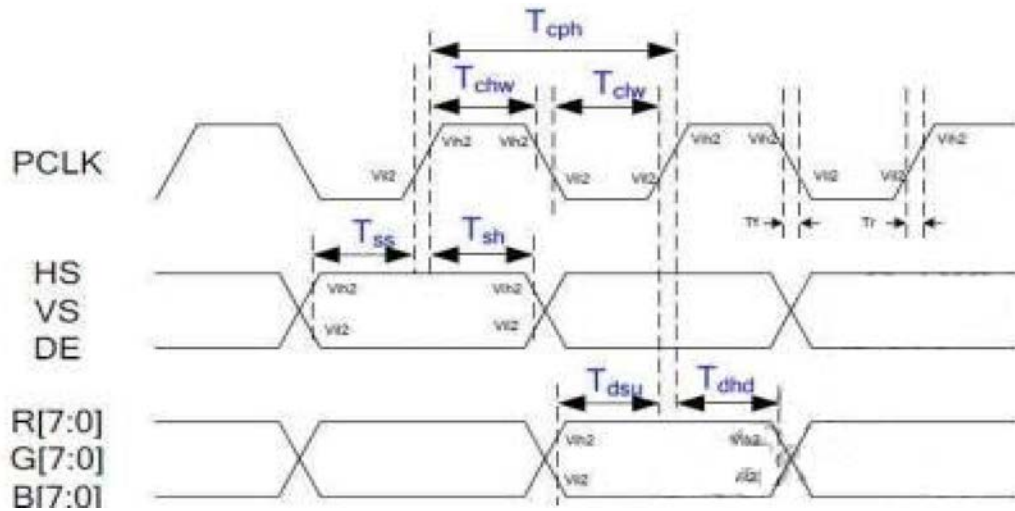

Figure: REF setting

9. Optical Specification

Ta=25°C

Item	Symbol	Condition	Min	Typ.	Max.	Unit	Remark
Contrast Ratio	CR	$\theta=0^\circ$	800	1400	-		Note1 Note2
Response Time	Tr	25°C	-	-	30	ms	Note1 Note3
	Tf		-	-	-		
View Angles	ΘT	$CR \geq 10$	-	80	-	Degree	Note 4
	ΘB		-	80	-		
	ΘL		-	80	-		
	ΘR		-	80	-		
Chromaticity	White	x	Brightness is on	Typ-0.05	TBD	Typ+0.05	Note5, Note1
		y			TBD		
	Red	x			0.641		
		y			0.334		
	Green	x			0.331		
		y			0.637		
	Blue	x			0.149		
		y			0.046		
Luminance	L		-	450	-	cd/m ²	Note1 Note6
Uniformity	U		75	-	-	%	Note1 Note7

Note 1: Definition of optical measurement system.

Temperature = 25°C(±3°C)

LED back-light: ON, Environment brightness < 150 lx

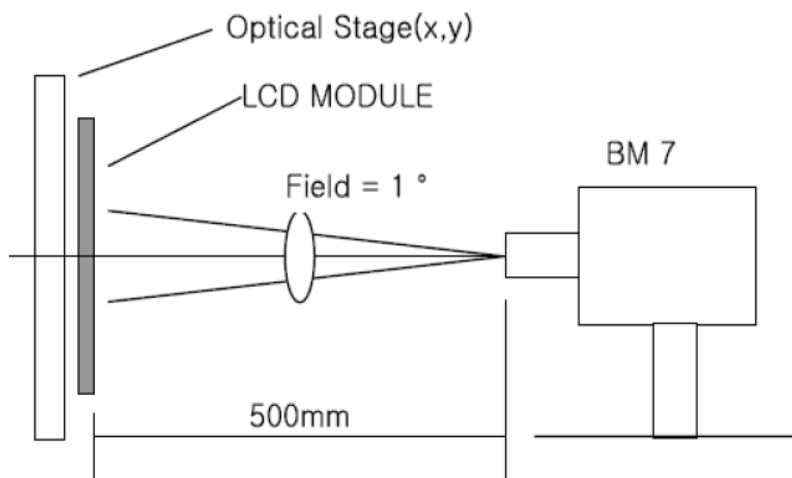

Note 2: Contrast ratio is defined as follow:

$$\text{Contrast Ratio} = \frac{\text{Surface Luminance with all white pixels}}{\text{Surface Luminance with all black pixels}}$$

Note 3: Response time is defined as follow:

Response time is the time required for the display to transition from black to white (Rise Time, T_r) and from white to black (Decay Time, T_f).

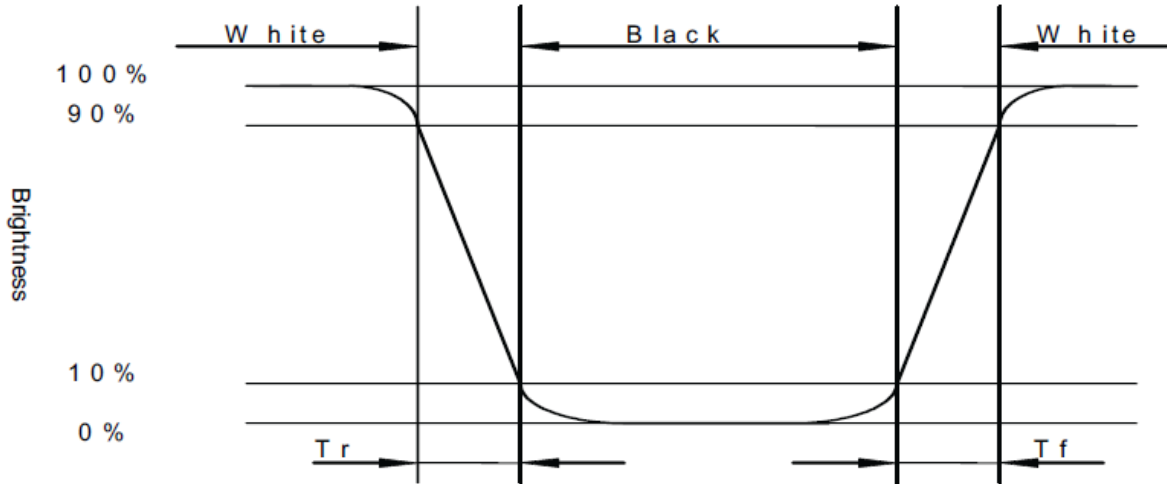

Note 4: Viewing angle range is defined as follow:

Viewing angle is measured at the center point of the LCD.

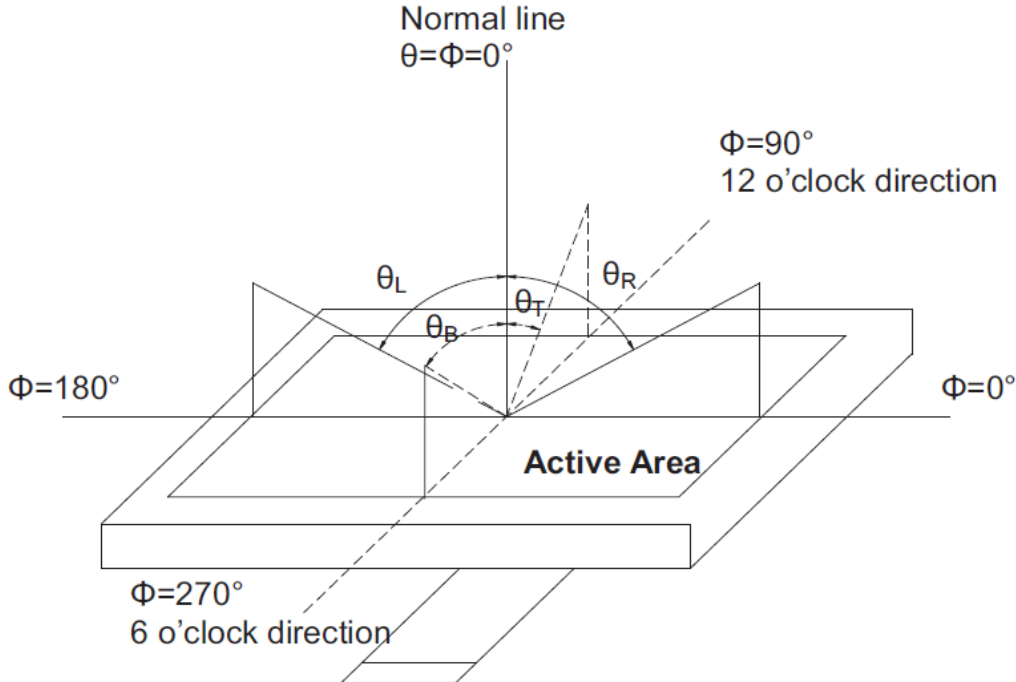

Note 5: Color chromaticity is defined as follow: (CIE1931)

Color coordinates measured at center point of LCD.

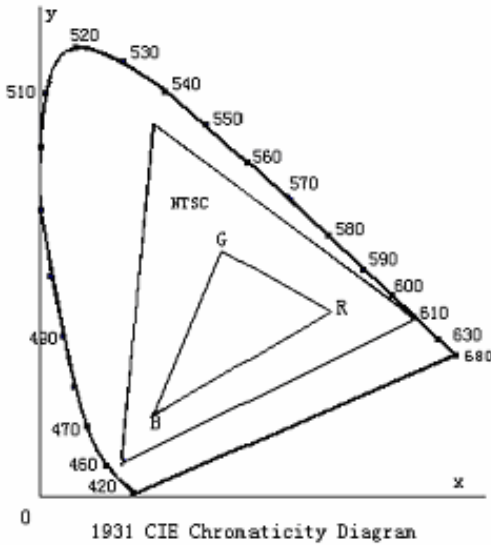

$$S = \frac{\text{area of RGB triangle}}{\text{area of NTSC triangle}} \times 100\%$$

Note 6: Luminance is defined as follow:

Luminance is defined as the brightness of all pixels “White” at the center of display area on optimum contrast.

Note 7: Luminance Uniformity is defined as follow:

Active area is divided into 9 measuring areas (Refer Fig. 2). Every measuring point is placed at the center of each measuring area.

$$\text{Uniformity}(U) = \frac{\text{Minimum Luminance(brightness) in 9 points}}{\text{Maximum Luminance(brightness) in 9 points}}$$

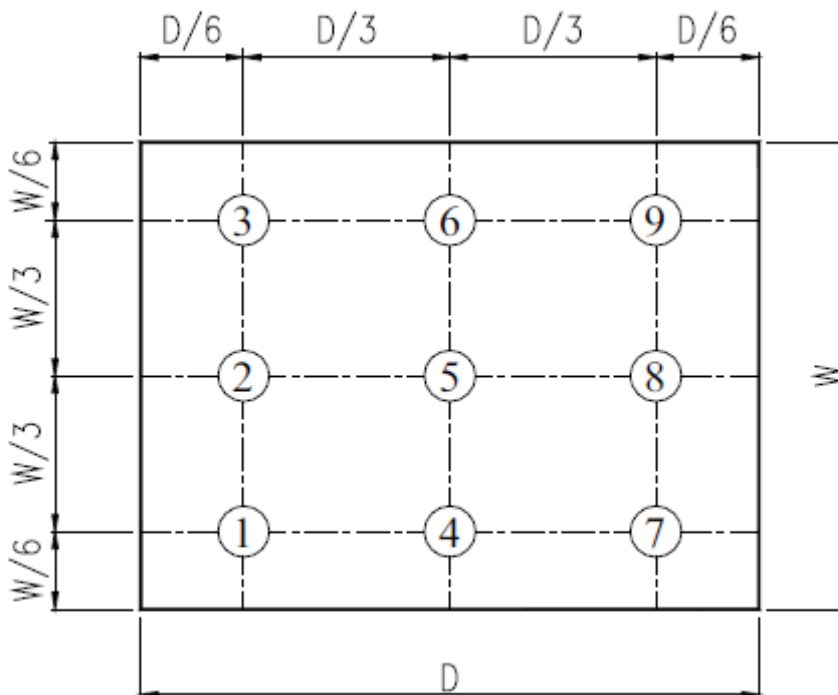

Fig. 2 Definition of uniformity

10. Environmental / Reliability Tests

No	Test Item	Condition	Judgment criteria
1	High Temp Operation	Ts=+70°C, 240hrs	Per table in below
2	Low Temp Operation	Ta=-20°C, 240hrs	Per table in below
3	High Temp Storage	Ta=+80°C, 240hrs	Per table in below
4	Low Temp Storage	Ta=-30°C, 240hrs	Per table in below
5	High Temp & High Humidity Storage	Ta=+60°C, 90% RH, 240hours	Per table in below (polarizer discoloration is excluded)
6	Thermal Shock (Non-operation)	-30°C 30 min~+80°C 30 min, Change time:5min, 10 Cycles	Per table in below
7	ESD (Operation)	C=150pF, R=330Ω, 5points/panel Air:±8KV, 5times; Contact:±4KV, 5 times;	Per table in below
8	Vibration (Non-operation)	Frequency range:10~55Hz, Stroke:1.5mm Sweep:10Hz~55Hz~10Hz 2 hours for each direction of X.Y.Z.	Per table in below
9	Shock (Non-operation)	60G 6ms, ±X,±Y,±Z 3times, for each direction	Per table in below
10	Package Drop Test	Height:80 cm, 1 corner, 3 edges, 6 surfaces	Per table in below

INSPECTION	CRITERION(after test)
Appearance	No Crack on the FPC, on the LCD Panel
Alignment of LCD Panel	No Bubbles in the LCD Panel No other Defects of Alignment in Active area
Electrical current	Within device specifications
Function / Display	No Broken Circuit, No Short Circuit or No Black line No Other Defects of Display

11. Precautions for Use of LCD Modules

11.1 Safety

The liquid crystal in the LCD is poisonous. Do not put it in your mouth. If the liquid crystal touches your skin or clothes, wash it off immediately using soap and water.

11.2 Handling

- A. The LCD and touch panel is made of plate glass. Do not subject the panel to mechanical shock or to excessive force on its surface.
- B. Do not handle the product by holding the flexible pattern portion in order to assure the reliability
- C. Transparency is an important factor for the touch panel. Please wear clear finger sacks, gloves and mask to protect the touch panel from finger print or stain and also hold the portion outside the view area when handling the touch panel.
- D. Provide a space so that the panel does not come into contact with other components.
- E. To protect the product from external force, put a covering lens (acrylic board or similar board) and keep an appropriate gap between them.
- F. Transparent electrodes may be disconnected if the panel is used under environmental conditions where dew condensation occurs.
- G. Property of semiconductor devices may be affected when they are exposed to light, possibly resulting in IC malfunctions.
- H. To prevent such IC malfunctions, your design and mounting layout shall be done in the way that the IC is not exposed to light in actual use.

11.3 Static Electricity

- A. Ground soldering iron tips, tools and testers when they are in operation.
- B. Ground your body when handling the products.
- C. Power on the LCD module before applying the voltage to the input terminals.
- D. Do not apply voltage which exceeds the absolute maximum rating.
- E. Store the products in an anti-electrostatic bag or container.
- F. Peel off the LCM protective film slowly since static electricity may be generated.

11.4 Storage

- A. Store the products in a dark place at $+25^{\circ}\text{C} \pm 10^{\circ}\text{C}$ with low humidity (40% RH to 60% RH). Don't expose to sunlight or fluorescent light.
- B. Storage in a clean environment, free from dust, active gas, and solvent.

11.5 Cleaning

- A. Do not wipe the touch panel with dry cloth, as it may cause scratch.
- B. Wipe off the stain on the product by using soft cloth moistened with ethanol. Do not allow ethanol to get in between the upper film and the bottom glass. It may cause peeling issue or defective operation. Do not use any organic solvent or detergent other than ethanol.

11.6 Cautions for installing and assembling

- A. Bezel edge must be positioned in the area between the Active area and View area. The bezel may press the touch screen and cause activation if the edge touches the active area. A gap of approximately 0.5mm is needed between the bezel and the top electrode. It may cause unexpected activation if the gap is too narrow. There is a tolerance of 0.2 to 0.3mm for the outside dimensions of the touch panel and tail. A gap must be made to absorb the tolerance in the case and connector.
- B. In order to make the display assembly stable and firm, DLC recommends to design some supporting at the display backside, especially for the display with tape-attached touch panel, such supporting is important and essential, or else, the display may drop-off from front after some period of time.
- C. Do not display the fixed pattern for a long time because it may develop image sticking due to the LCD structure. If the screen is displayed with fixed pattern, use a screen saver.

