

DLC Display Co., Limited

德爾西顯示器有限公司



MODEL No:DLC0700BWM27RT-R-2

TEL: 86-755-86029824

FAX: 86-755-86029827

E-MAIL: sales@dlcdisplay.com

WEB: www.dlcdisplay.com



Record of Revision

Date	Revision No.	Summary
2017-12-25	1.0	Rev 1.0 was issued
2019-11-11	1.1	Add driver IC model

1. Scope

This data sheet is to introduce the specification of DLC0700BWM27RT-R-2 active matrix TFT module. It is composed of a color TFT-LCD panel, driver IC, FPC, Resistive touch panel and a backlight unit. The 7.0" display area contains 800 (RGB) x 480 pixels.

2. Application

Digital equipments which need color display outdoor, mobile navigator/video systems.

3. General Information

Item	Contents	Unit
Size	7.0	inch
Resolution	800(RGB) X 480	/
Interface	Parallel 24-bit RGB	/
Technology type	a-Si TFT	/
Pixel pitch	0.1926 x 0.1790	mm
Pixel Configuration	R.G.B. Vertical Stripe	
Outline Dimension (W x H x D)	164.90 x 100.00 x 4.45	mm
Active Area	154.08 x 85.92	mm
Display Mode	Transmissive	/
Viewing Direction	12 o'clock	/
Driver IC	EK9713CA & EK73002ACGB	/
Backlight Type	LED	/
Weight	TBD	g

4. Outline Drawing

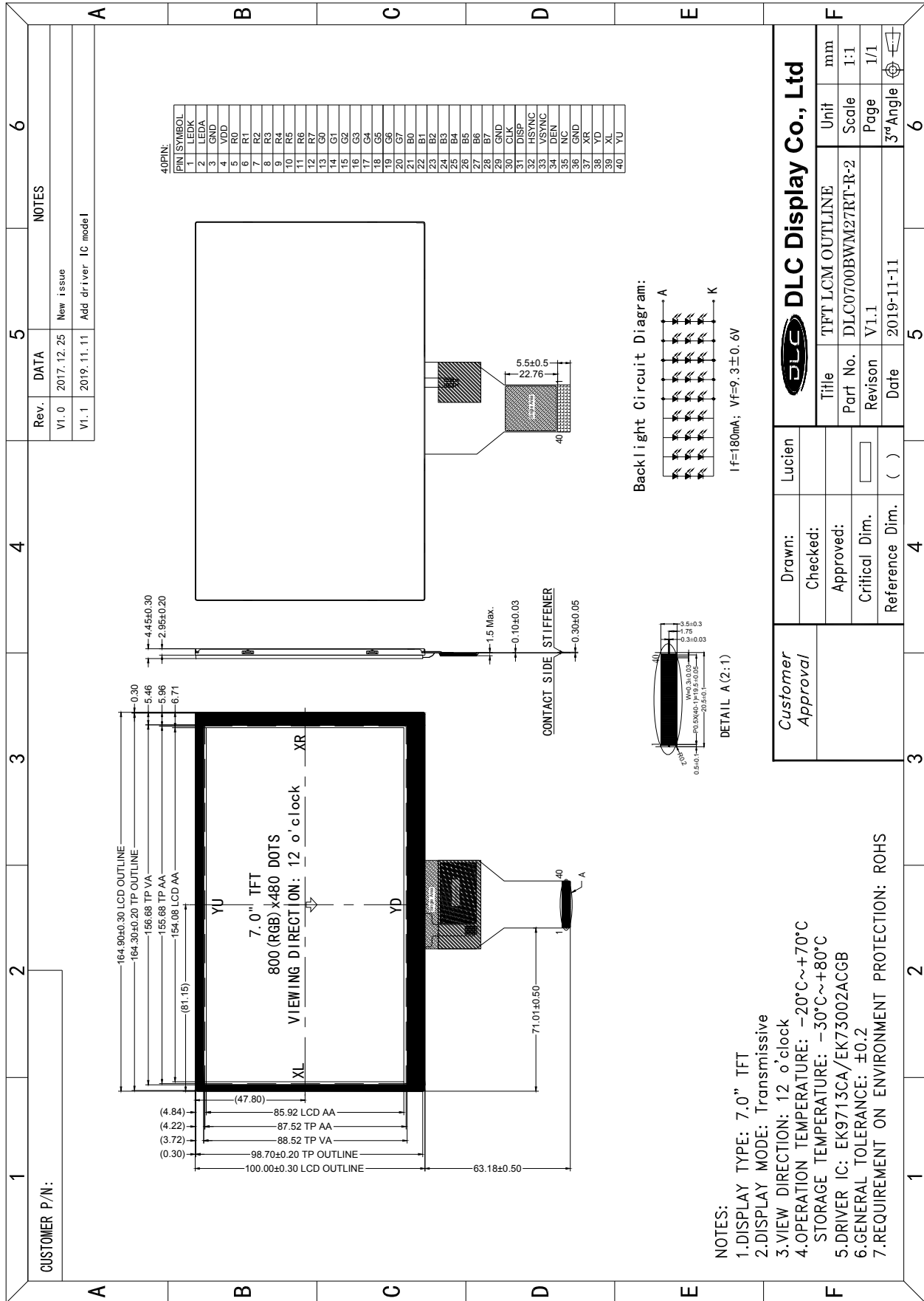

5. Interface signals

No	Symbol	Description	Remarks
1	LEDK	Power for LED Backlight Cathode	
2	LEDA	Power for LED Backlight Anode	
3	GND	Power ground	
4	VDD	Power supply	
5~12	R0~R7	Red data	
13~20	G0~G7	Green data	
21~28	B0~B7	Blue data	
29	GND	Power ground	
30	CLK	Sample clock	
31	DISP	Display on/off	
32	HSYNC	Horizontal sync signal	
33	VSYNC	Vertical sync signal	
34	DE	Data enable	
35	NC	No connect	
36	GND	Power ground	
37	XR	Touch panel pin	
38	YD	Touch panel pin	
39	XL	Touch panel pin	
40	YU	Touch panel pin	

Note: The recommended connector: FH12A-40S-0.5SH.

6. Absolute maximum Ratings

6.1. Electrical Absolute max. ratings

Parameter	Symbol	MIN	MAX	Unit	Remark
Power Supply Voltage	VDD	0.3	6.0	V	Ta=25°C
Input voltage	VI	-0.3	VCC+0.3	V	

6.2. Environment Conditions

Item	Symbol	MIN	MAX	Unit	Remark
Operating Temperature	TOPR	-20	70	°C	
Storage Temperature	TSTG	-30	80	°C	

7. Electrical Specifications

7.1 Electrical characteristics

GND=0V, Ta=25°C

Item	Symbol	MIN	TYP	MAX	Unit	Remark
Power Supply Voltage	VDD	2.5	3.3	3.6	V	
Power Supply Current	ICC	--	120	--	mA	VDD=3.3V

7.2 LED Backlight

Ta=25°C

Item	Symbol	MIN	TYP	MAX	Unit	Remark
Forward Current	IBL	--	180	-	mA	Note1
Forward Voltage	VBL	--	9.3	--	V	
LED Life time		--	25,000	--	Hr	Note2

Notes:

1. The LED Supply Voltage is defined by the number of LED at Ta=25°C and IL =180mA.
2. The "LED life time" is defined as the module brightness decrease to 50% original brightness at Ta=25°C and IL =180mA. The LED lifetime could be decreased if operating IL is larger than180mA

Backlight Circuit Diagram:

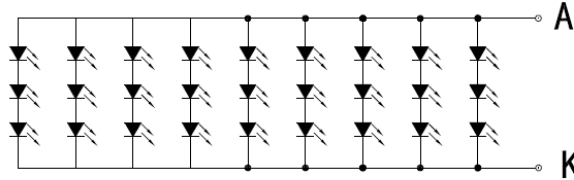

$$I_f=180\text{mA}; V_f=9.3 \pm 0.6\text{V}$$

8. Command/AC Timing

8.1.AC Electrical Characteristics

Item	Symbol	Rating			Unit	Remark
		MIN	TYP	MAX		
HS setup time	Thst	8	-	-	ns	
HS hold time	Thhd	8	-	-	ns	
VS setup time	Tvst	8	-	-	ns	
VS hold time	Tvhd	8	-	-	ns	
Data setup time	Tdsu	8	-	-	ns	
Data hole time	Tdhd	8	-	-	ns	
DE setup time	Tesu	8	-	-	ns	
DE hole time	Tehd	8	-	-	ns	
DVDD Power On Slew rate	TPOR	-	-	20	ms	From 0 to 90% DVDD
RESET pulse width	TRst	1	-	-	ms	
DCLK cycle time	Tcoh	20	-	-	ns	
DCLK pulse duty	Tcwh	40	50	60	%	

8.2. Input Clock and Data Timing Diagram

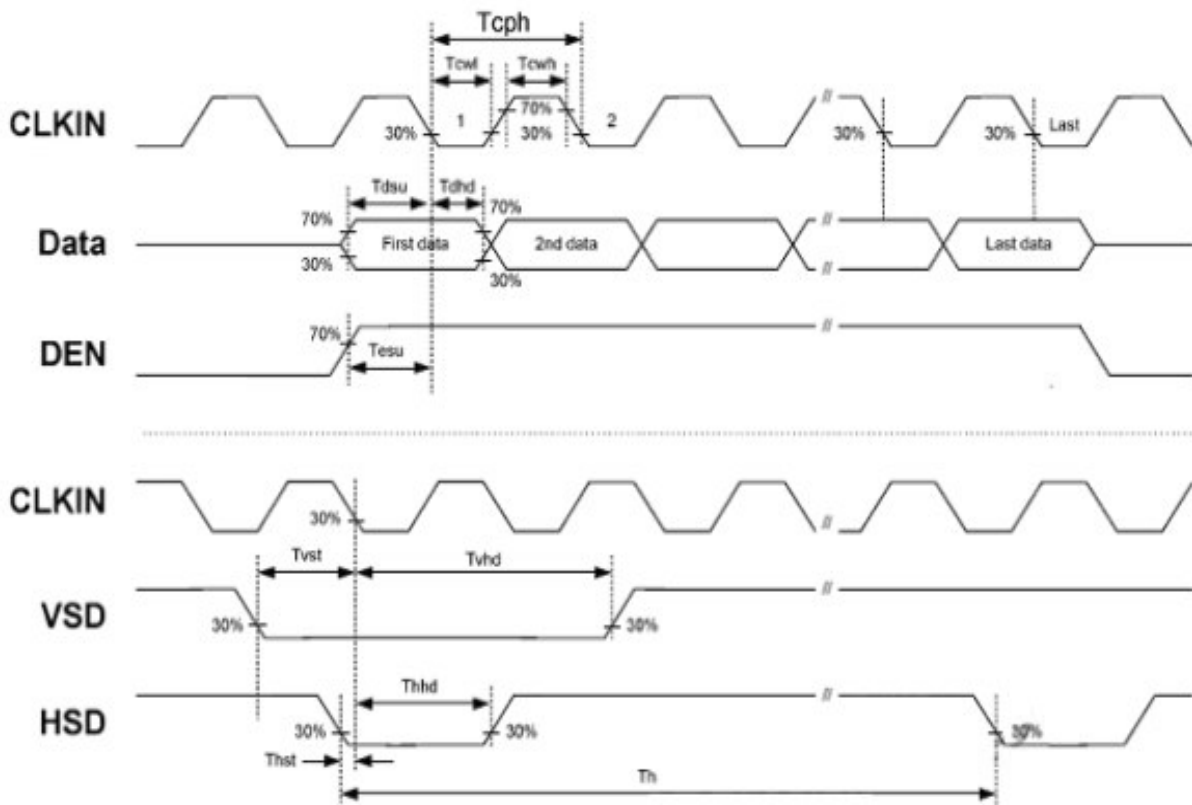

8.3. Timing

Item	Symbol	Rating			Unit	Remark
		MIN	TYP	MAX		
Horizontal Display Area	Thd	--	800	--	DCLK	
DCLK Frequency	Fclk	26.4	33.3	46.8	MHZ	
One Horizontal Line	Th	862	1056	1200	DCLK	
HS pulse width	Thpw	1	--	40	DCLK	
HS Blanking	thb	46	46	46	DCLK	
HS Front Porch	thfp	16	210	354	DCLK	

Item	Symbol	Rating			Unit	Remark
		MIN	TYP	MAX		
Vertical Display Area	Tvd	--	480	--	TH	
VS period time	Tv	510	525	650	TH	
VS pulse width	Tvpw	1	--	20	TH	
VS Blanking	tvb	23	23	23	TH	
VS Front Porch	tvfp	7	22	14	TH	

8.4. Data Input Format

8.4.1. horizontal input timing diagram



8.4.2. Vertical input timing diagram

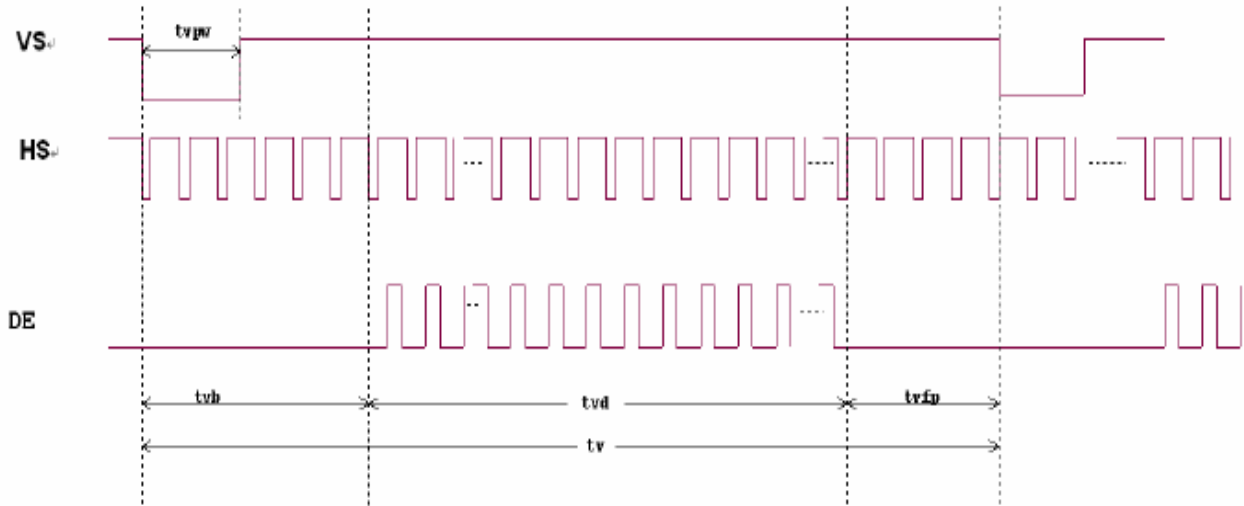

9. Optical Specification

Item	Symbol	Condition	Min	Typ.	Max.	Unit	Remark	
Contrast Ratio	CR	$\theta=0^\circ$	400	500	-		Note1 Note2	
Response Time	TR	25°C	-	10	20	ms	Note1 Note3	
	TF		-	15	30			
View Angles	ΘT	CR ≥ 10	40	50	-	Degree	Note 4	
	ΘB		60	70	-			
	ΘL		60	70	-			
	ΘR		60	70	-			
Chromaticity	White	Brightness is on	x	0.30	0.32	0.34		Note5, Note1
			y	0.32	0.34	0.36		
Luminance	L		-	400	-	cd/m ²	Note1 Note6	
Uniformity (White)	U		75	-	-	%	Note1 Note7	

Note 1: Definition of optical measurement system.

Temperature = 25°C(±3°C)

LED back-light: ON, Environment brightness < 150 lx

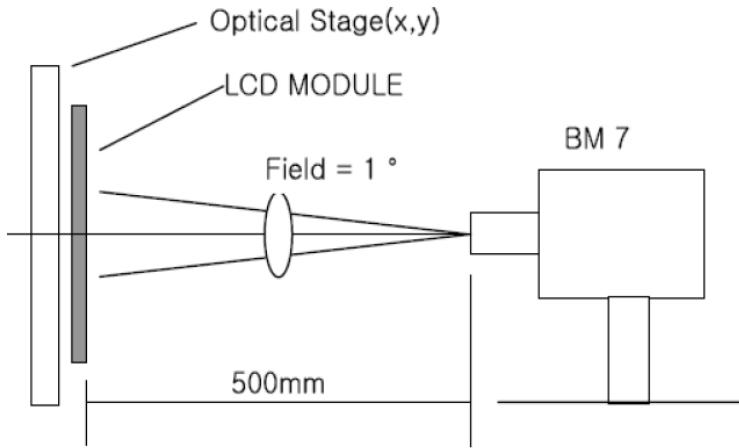

Note 2: Contrast ratio is defined as follow:

$$\text{Contrast Ratio} = \frac{\text{Surface Luminance with all white pixels}}{\text{Surface Luminance with all black pixels}}$$

Note 3: Response time is defined as follow:

Response time is the time required for the display to transition from black to white (Rise Time, Tr) and from white to black(Decay Time, Tf).

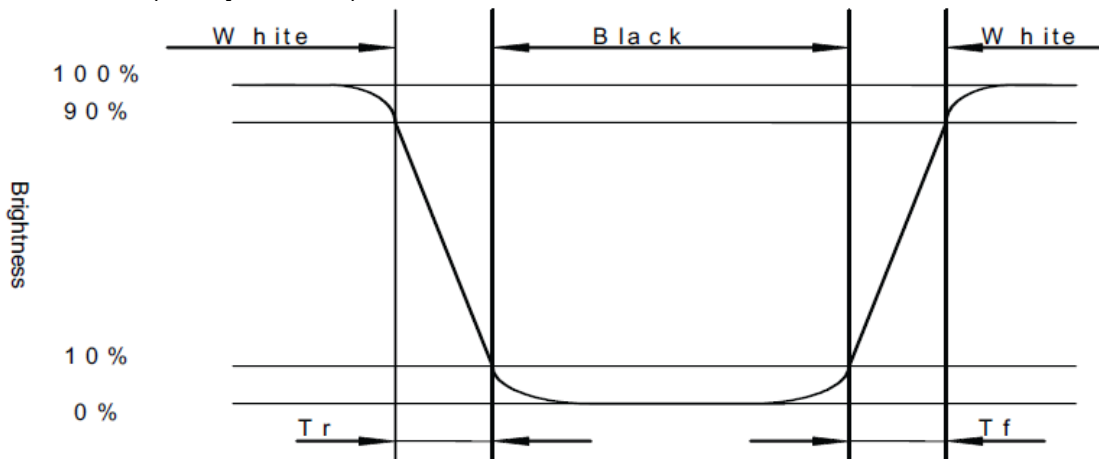

Note 4: Viewing angle range is defined as follow:

Viewing angle is measured at the center point of the LCD.

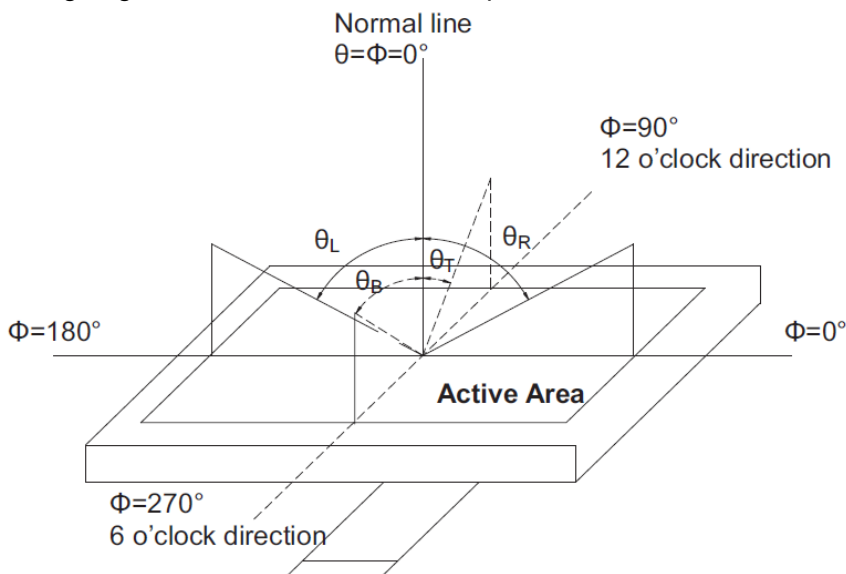

Note 5: Color chromaticity is defined as follow: (CIE1931)

Color coordinates measured at center point of LCD.

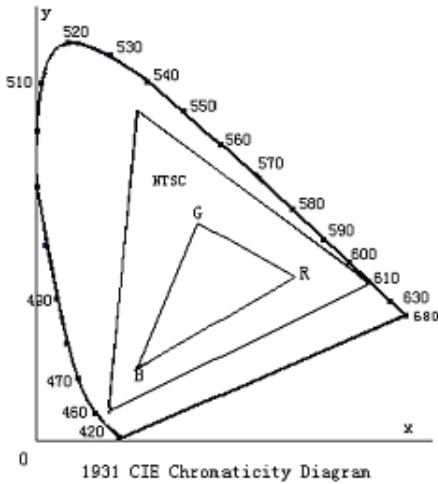

$$S = \frac{\text{area of RGB triangle}}{\text{area of NTSC triangle}} \times 100\%$$

Note 6: Luminance is defined as follow:

Luminance is defined as the brightness of all pixels “White” at the center of display area on optimum contrast.

Note 7: Luminance Uniformity is defined as follow:

Active area is divided into 9 measuring areas (Refer Fig. 2). Every measuring point is placed at the center of each measuring area.

$$\text{Uniformity (U)} = \frac{\text{Minimum Luminance(brightness) in 9 points}}{\text{Maximum Luminance(brightness) in 9 points}}$$

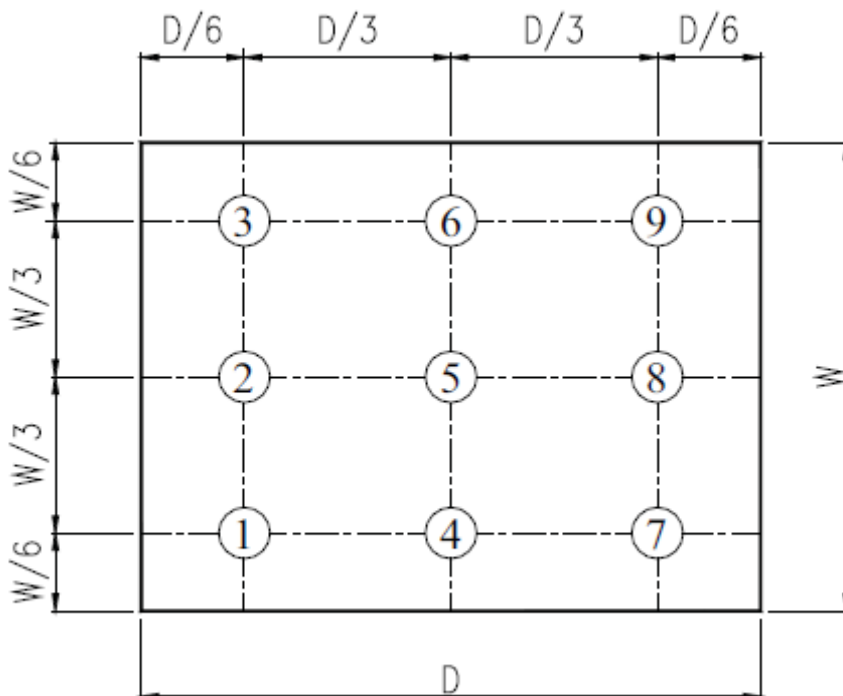

Fig. 2 Definition of uniformity

10.Environmental / Reliability Tests

No	Test Item	Condition	Judgment criteria
1	High Temp Operation	Ta= +70°C, 120hrs	Per table in below
2	Low Temp Operation	Ta= -20°C, 120hrs	Per table in below
3	High Temp Storage	Ta= +80°C, 120hrs	Per table in below
4	Low Temp Storage	Ta= -30°C, 120hrs	Per table in below
5	High Temp & High Humidity Storage	Ta=+60°C, 90% RH, 120 hours	Per table in below (polarizer discoloration is excluded)
6	Thermal Shock (Non-operation)	-30°C 30 min~+70°C 30 min, Change time:5min, 10 Cycles	Per table in below
7	ESD (Operation)	C=150pF, R=330Ω · 5points/panel Air:±8KV, 5times; Contact:±4KV, 5 times;	Per table in below
8	Vibration (Non-operation)	Frequency range:10~55Hz, Stroke:1.5mm Sweep:10Hz~55Hz~10Hz 2 hours for each direction of X.Y.Z.	Per table in below
9	Shock (Non-operation)	60G 6ms, ±X,±Y,±Z 3times, for each direction	Per table in below
10	Package Drop Test	Height:80 cm, 1 corner, 3 edges, 6 surfaces	Per table in below

INSPECTION	CRITERION(after test)
Appearance	No Crack on the FPC, on the LCD Panel
Alignment of LCD Panel	No Bubbles in the LCD Panel No other Defects of Alignment in Active area
Electrical current	Within device specifications
Function / Display	No Broken Circuit, No Short Circuit or No Black line No Other Defects of Display

11. Precautions for Use of LCD Modules

11.1 Safety

The liquid crystal in the LCD is poisonous. Do not put it in your mouth. If the liquid crystal touches your skin or clothes, wash it off immediately using soap and water.

11.2 Handling

- A. The LCD and touch panel is made of plate glass. Do not subject the panel to mechanical shock or to excessive force on its surface.
- B. Do not handle the product by holding the flexible pattern portion in order to assure the reliability
- C. Transparency is an important factor for the touch panel. Please wear clear finger sacks, gloves and mask to protect the touch panel from finger print or stain and also hold the portion outside the view area when handling the touch panel.
- D. Provide a space so that the panel does not come into contact with other components.
- E. To protect the product from external force, put a covering lens (acrylic board or similar board) and keep an appropriate gap between them.
- F. Transparent electrodes may be disconnected if the panel is used under environmental conditions where dew condensation occurs.
- G. Property of semiconductor devices may be affected when they are exposed to light, possibly resulting in IC malfunctions.
- H. To prevent such IC malfunctions, your design and mounting layout shall be done in the way that the IC is not exposed to light in actual use.

11.3 Static Electricity

- A. Ground soldering iron tips, tools and testers when they are in operation.
- B. Ground your body when handling the products.
- C. Power on the LCD module before applying the voltage to the input terminals.
- D. Do not apply voltage which exceeds the absolute maximum rating.
- E. Store the products in an anti-electrostatic bag or container.

11.4 Storage

- A. Store the products in a dark place at $+25^{\circ}\text{C} \pm 10^{\circ}\text{C}$ with low humidity (40% RH to 60% RH). Don't expose to sunlight or fluorescent light.
- B. Storage in a clean environment, free from dust, active gas, and solvent.

11.5 Cleaning

- A. Do not wipe the touch panel with dry cloth, as it may cause scratch.
- B. Wipe off the stain on the product by using soft cloth moistened with ethanol. Do not allow ethanol to get in between the upper film and the bottom glass. It may cause peeling issue or defective operation. Do not use any organic solvent or detergent other than ethanol.

11.6 Cautions for installing and assembling

- A. Bezel edge must be positioned in the area between the Active area and View area. The bezel may press the touch screen and cause activation if the edge touches the active area. A gap of approximately 0.5mm is needed between the bezel and the top electrode. It may cause unexpected activation if the gap is too narrow. There is a tolerance of 0.2 to 0.3mm for the outside dimensions of the touch panel and tail. A gap must be made to absorb the tolerance in the case and connector.
- B. In order to make the display assembly stable and firm, DLC recommends to design some supporting at the display backside, especially for the display with tape-attached touch panel, such supporting is important and essential, or else, the display may drop-off from front after some period of time.
- C. Do not display the fixed pattern for a long time because it may develop image sticking due to the LCD structure. If the screen is displayed with fixed pattern, use a screen saver.

